

Sekundární vzduch
Sekundärluft
Secondary air

Primární vzduch
Primärluft
Primary air

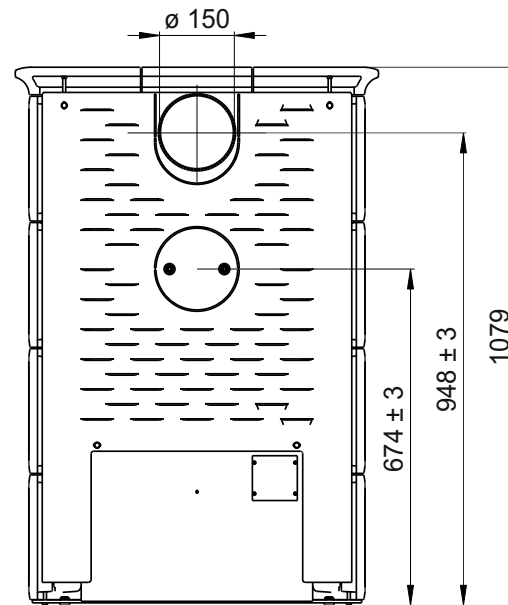

Výška osy zadního odvodu spalin (mm) - Alternativy
Rauchrohrabgang hinten (mm) - Alternativen
Height of the rear outlet (mm) - Alternatives

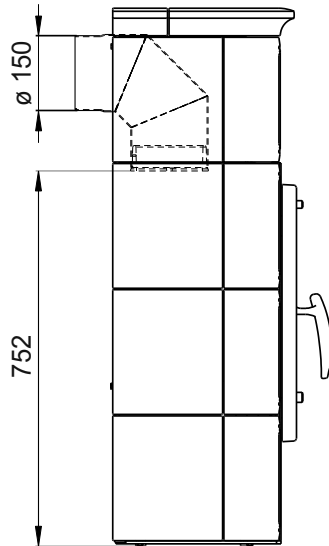
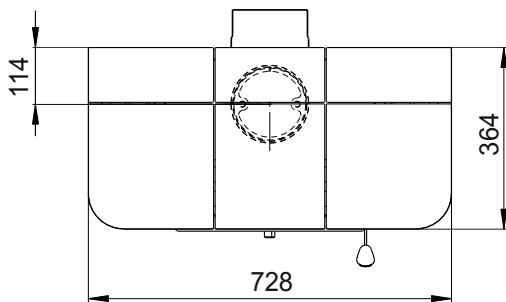

Rozměry v mm
Maße in mm
Dimensions in mm

Kachlová kamna Kachelöfen Tiled Stoves	Typ Type Typ	CATANIA 1	
Hmotnost Gewicht Weight	160 kg	Rozměry topeniště (výška x šířka x hloubka) Maße Feuerraum (höhe x breite x tiefe) Combustion Chamber Dimensions (height x width x depth)	280 x 340 x 200 (mm)
		Hein & spol. - keramické závody, spol. s r. o. Odry - Tošovice	