

Sekundární vzduch
 Sekundärluft
 Secondary air
 Primární vzduch
 Primärluft
 Primary air

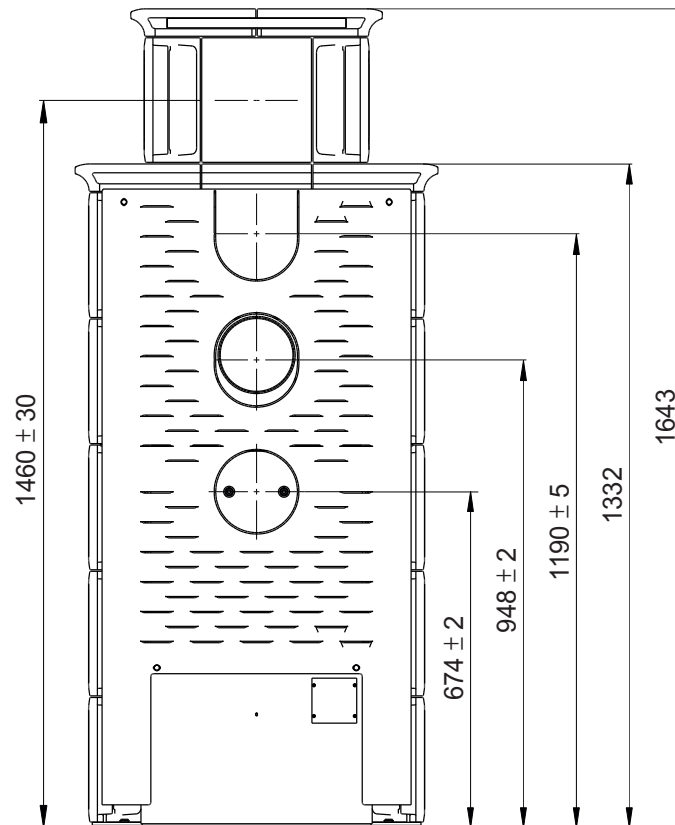

Výška osy zadního odvodu spalin (mm) - Alternativy
 Rauchrohrabgang hinten (mm) - Alternativen
 Height of the rear outlet (mm) - Alternatives

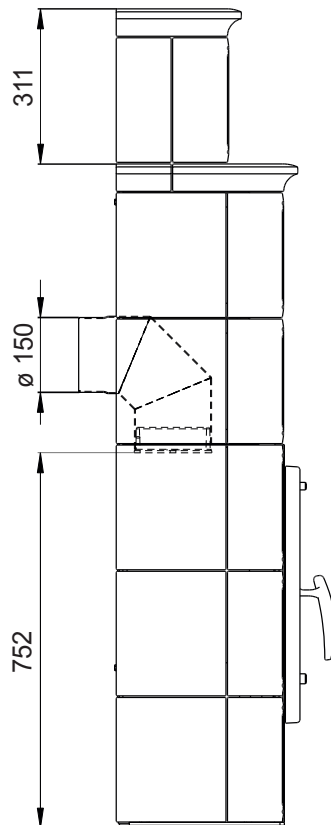
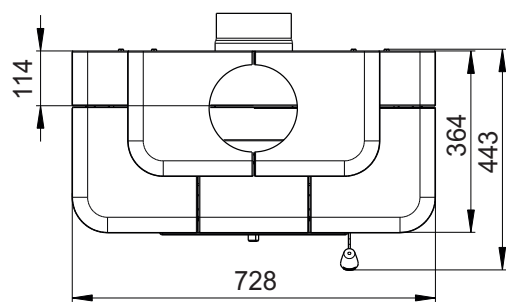

Rozměry v mm
 Maße in mm
 Dimensions in mm

Kachlová kamna Kachelöfen Tiled Stoves	Typ Type Typ CATANIA 2 H
Hmotnost Gewicht Weight 197 (kg)	Rozměry topeniště (výška x šířka x hloubka) Maße Feuerraum (höhe x breite x tiefe) Combustion Chamber Dimensions (height x width x depth) 280 x 340 x 200 (mm)
Hein & spol. - keramické závody, spol. s r. o. Odry - Tošovice	